

OCTAVE

V 16 Single Ended

Owner's Manual

English

INTRODUCTION

Congratulations and thank you for choosing OCTAVE

V 16 Single Ended

You are now the owner of one of the world's most innovative and reliable amplifiers. Look after it, and it will provide you many years of listening pleasure.

You often hear people claim that tube amplifier design has not progressed for years. The operating principles of tubes have indeed been documented extensively and are well known to amplifier designers. Of course, the same can be said for transistor amplifiers.

However, advances in both technologies are still possible thanks to the development of innovative and improved components, our greater appreciation of the fundamental principles and, of course, deeper and more advanced insights into the interaction of amplifier and loudspeaker. With tube amplifiers in particular, a general reluctance to depart from the classic circuit designs has not done the technology any favors. Although today's loudspeakers and source equipment provide better performance than ever before, they also present greater demands on amplifiers. Modern sound reproduction equipment delivers a level of performance at a price that simply would not have been possible 20 or even 10 years ago.

These advances have been achieved through the application of the latest technological developments as they become available and affordable. OCTAVE has specialized in tube amplification for more than 30 years, during which time we have developed a number of innovative technologies that have earned us a reputation as one of the leaders in the field.

Here's wishing you many happy hours of musical pleasure!



Andreas Hofmann

CONTENTS

	Page
Introduction	3
1. Description of the V 16 Single Ended	7
2. Safety instructions	9
2.1 Before you begin	9
2.2 Placement	10
2.3 Warranty.....	10
3. Getting started.....	11
3.1 Unpacking, package contents	11
3.2 Removing the grille	11
3.3 Installing the power tubes	12
3.4 Switching on for the first time: the Soft-Start feature	13
3.5 Connecting other components	13
4. Controls – the front panel.....	14
5. Connections – the rear panel.....	16
6. Advanced functions	18
6.1 Subsonic Filter	18
6.2 Protection	18
6.3 Soft-Start	19
6.4 Speaker Operation - BIAS Selector	19
6.5 Headphone Operation - OUT Selector.....	19
6.6 Ecomode	19
7. Tubes	20
7.1 Removing the grille (see 3.2)	20
7.2 Tube layout	20
7.3 Replacing the tubes	21
7.4 Running in the tubes	21
7.5 Tube service life	21
8. Remote Control	22
9. Option Pre-Out / Filter Function	23
9.1 Regulated preamplifier output – Pre-Out	23
9.2 Setting of the Filter Function	24
9.2.1 Jumper setting “OFF”	24
9.2.2 Jumper setting “ON”	24
9.3 Setup with an active subwoofer	25
9.4 Bi-amping systems	25
9.5 Bi-amped systems with Level Adjustor	26
9.5.1 Level Adjustor option.....	26
10. Option (Super) Black Box.....	27
10.1 Black Box option	27
10.2 Connecting to the amplifier	27
10.3 Super Black Box option.....	28
10.4 Technical Data	28
11. Troubleshooting	29
11.1 Faults caused by external issues.....	29
11.2 Faults caused by tubes, faulty tubes.....	30
12. Specifications and Dimensions	32

1. DESCRIPTION OF THE V 16 Single Ended

The founding principle at OCTAVE has always been to apply modern innovations to classic tube technology.

OCTAVE technology entails a further developed tube amplifier topology utilizing an innovative, independent approach until the traits that correspond to the company philosophy are achieved: powerful dynamics, low noise, wide bandwidth, incredible stability, extended lifetime, and comprehensive safety. For over 30 years now, OCTAVE has exclusively crafted high-end amplification products that have fully embodied these aforementioned characteristics. The OCTAVE approach has been market proven and validated, and no other audio company has achieved what OCTAVE has accomplished in this regard.

The time has now come for OCTAVE to apply the company's exclusive amplifier technologies to a single-ended design, as this circuitry is desirable for its natural audio reproduction and is capable of realizing clear sonic benefits that are particularly ideal for high-efficiency loudspeakers as well as for headphones. Single-ended amplifiers possess a naturally harmonic sonic signature and offer an extremely lucid midrange, as the music signal is not split and thus no crossover distortions of the positive and negative half-waves arise.

Developing a single-ended Class A circuitry presented a unique challenge for OCTAVE: how to fully overcome the disadvantages of this amplifier principle while bringing its sonic benefits to the forefront.

OCTAVE applied its myriad technical innovations and proprietary output transformer technology to develop a sophisticated new amplifier to meet this challenge: The result is the all-new OCTAVE V 16 Single Ended integrated amplifier, the company's first ever single-ended design.

While the natural sonic character and midrange clarity of the single-ended circuit is uniquely desirable, there are also some known limitations to the single-ended amplifier topology that needed to be addressed:

1. *Level reduction in the bass frequencies* – OCTAVE has eliminated this problem inherent in single-ended amplifiers via a new, highly specialized magnetic-field compensated output transformer. OCTAVE is renowned for its proprietary transformer designs which are developed, wound and meticulously crafted in-house. The power bandwidth in the bass frequencies of the OCTAVE V 16 Single Ended remains linear up to 10Hz as a result of this customized transformer design.
2. *Level reduction in the high frequency range and limited bandwidth* - By means of specific driver stages and an optimization of the feedback, OCTAVE has been able to extend the bandwidth of the OCTAVE V 16 Single Ended from 10 Hz to 100 kHz, a bandwidth spec that was previously considered impossible to achieve from a single-ended amplifier design.
3. *Relatively high residual noise in the loudspeaker output* - The level of hum in the OCTAVE V 16 Single Ended was rendered virtually immeasurable via OCTAVE its optimized positioning of the mains transformer in respect to the output transformer, which also negates the need for an outboard power supply. The company's sophisticated electronic stabilization circuits serve to further ensure that any sources of noise or hum is eliminated.
 - a. The low-frequency noise level achieved at the loudspeaker as well as the head-phone outputs is in the range of – 110 dB / 1 W at 8 ohms, which corresponds to approximately 15 – 20 μ V at 50 Hz.

1. DESCRIPTION OF THE V 16 Single Ended

4. *High temperatures during high-current rest in Class-A operation* – Most single-ended Class-A amplifier designs are extremely inefficient, typically idling between three to five times the output power. Thus these devices become very hot during normal operation.
 - A. The OCTAVE V 16 Single Ended single-ended amplifier utilizes an adaptive three-step setting of the Class-A mode. The Class-A level is automatically adjusted between 100% and 35% to the load profile of the loudspeaker (4/8 ohms) and headphones, which considerably reduces the amplifier's operating temperature, while significantly extending its lifespan as well.
 - B. In addition, the OCTAVE V 16 Single Ended features a unique version of OCTAVE its energy-saving "Ecomode" technology, which serves to reduce the Class-A level to 35% during pauses in the music signal, and inaudibly rises when a musical signal is once again present.
5. *Disadvantages of expensive, directly heated triodes* - OCTAVE has developed the OCTAVE V 16 Single Ended to operate a KT 120 pentode tube in a triode circuit. It is ideally suited for single-ended Class A operation due to its particular characteristics: very high performance, excellent longevity, tight tolerances, and widespread availability – while avoiding the technical problems of a traditional triode tube such as the 300 B. The OCTAVE V 16 Single Ended architecture will thus also allow the use of KT 150, KT 88, or 6550 tubes, for example, making its design extremely universal.

OCTAVE has also equipped the V16 Single Ended with an optional Pre-Out feature. While adding complexity, this option affords great flexibility. Thus the V 16 Single Ended is a perfect companion to myriad system setups, and can be used to drive headphones, high efficiency loudspeakers, hybrid systems (with active bass), or in conventional bi-amp setups. An equalizer is used to cut the deep bass frequencies (below 80 Hz), so the V 16 Single Ended is only responsible for the midrange and treble. The frequency range is optimized by Octave and thus not adjustable. One primary benefit in the case of bi-amping is to take advantage of the breathtakingly beautiful single ended performance in the sensitive mid and high frequency range while employing a separate power amp (or internal amp in the speaker) to handle the bass region.

The long development time of the OCTAVE V 16 Single Ended has surely paid off: an uncompromising single-ended Class-A integrated amplifier that delivers ultra-quiet operation highlighted by deep bass, a natural midrange and silky-smooth highs combined with an unsurpassed degree of reliability and longevity.

A pure, modern classic amplifier in every regard.

2. SAFETY INSTRUCTIONS

2.1 Before you begin

In case of emergency: disconnect the plug from the mains supply

Never use an amplifier that is damaged or faulty. Make sure it has been labeled as defective and that it cannot be used until it has been repaired by a qualified service engineer. Make sure that there is easy access to the IEC socket and power cable.

Do not open the case



There are dangerously high voltages and hot tubes inside this equipment. To avoid a burn or the risk of electric shock, never allow anyone except qualified personnel to open the case or remove the grill.

Service and maintenance

For reasons of safety, please ensure that servicing, repairs and other modifications to OCTAVE equipment are carried out only by a qualified technician. Defective fuses should also only be replaced by a qualified technician. Always replace fuses with ones of the same type and rating. If your amplifier requires servicing, please ship or take your equipment directly to OCTAVE or to one of our authorized service centers.

Symbols and terms used in warnings

The following warnings, symbols and terms are used in this document in compliance with the American National Standard ANSI Z535.6-2011:

	The general danger symbol, in conjunction with the terms CAUTION , WARNING , or DANGER , warns of the risk of severe injury.
	The triangle symbol with the lightning bolt warns of non-isolated, dangerous voltages inside the case and of hazards posed by electrical shocks. This work must be performed by a professional.
ATTENTION	Indicates a danger that could lead to damage or destruction of the device.
CAUTION	Indicates a danger that represents a low or medium risk of injury.
WARNING	Indicates a danger that could lead to death or severe injury.

Warning format

 WARNING TERM
Type and source of danger
Consequences of ignoring the warning
▶ Action needed to avoid danger

Before connecting

Make sure that the voltage of your amplifier matches your local mains voltage.

Grounding

This amplifier is a protection class 1 device, with an earth conductor. Therefore a three-pin power cable with a protective earth contact must be used (included in the scope of delivery).

2. SAFETY INSTRUCTIONS

2.2 Placement

Location

- OCTAVE equipment is designed strictly for use in a dry domestic environment. Do not use it in open air or in damp environments!
- Never place plants or liquid-filled containers on your amplifier. Take care that objects do not fall or liquids are not spilled into the enclosure. Should this happen, disconnect the mains plug immediately and have your amplifier checked by a qualified service technician.
- Condensation may form if the amplifier is taken from a cold environment into a warm one. In this case, wait until the amplifier has reached room temperature and is dry before switching it on.
- Avoid installing the amplifier close to sources of heat, such as heaters, or anywhere that it may be in direct sunlight.
- Do not operate your OCTAVE amplifier near flammable materials, gases, or vapors. Avoid areas where there may be heavy accumulations of dust or where the amplifier may be subject to mechanical vibration.
- Place your OCTAVE amplifier on a stable, even surface.

Cover

Never operate the amplifier without the cover.

Ventilation

- Ensure sufficient air circulation around your amplifier. If you intend to install your equipment in a cupboard or a shelf unit, ensure that there is at least a 10 centimeter gap between the ventilation slots and the walls all around the amplifier.
- To prevent heat accumulation, the back of the cupboard should have ventilation holes.
- Do not rest the equipment on a soft surface such as carpet or foam sheeting.

2.3 Warranty

OCTAVE can only guarantee the safety, reliability and performance of this unit if modifications and repairs are carried out by specialized personnel and if the amplifier is operated in accordance with the instructions contained in this manual.

3. GETTING STARTED

3.1. Unpacking, package contents

Scope of delivery	
<input type="checkbox"/>	Integrated tube amplifier V 16 Single Ended Line
<input type="checkbox"/>	1 set power tubes (serial equipment: 2 pc KT120)
<input type="checkbox"/>	Power cord
<input type="checkbox"/>	Remote control
<input type="checkbox"/>	2 screwdrivers: 1 x 3 mm Allen key for removing the cover 1 x TX10 screwdriver for TX10 screws
<input type="checkbox"/>	4 x M4 x 10 Torx screws TX10 for fixing the tube plate (without the grille)
<input type="checkbox"/>	Octave cleaning cloth and soft gloves
<input type="checkbox"/>	Owner's manual with certificate

3.2. Removing the grille

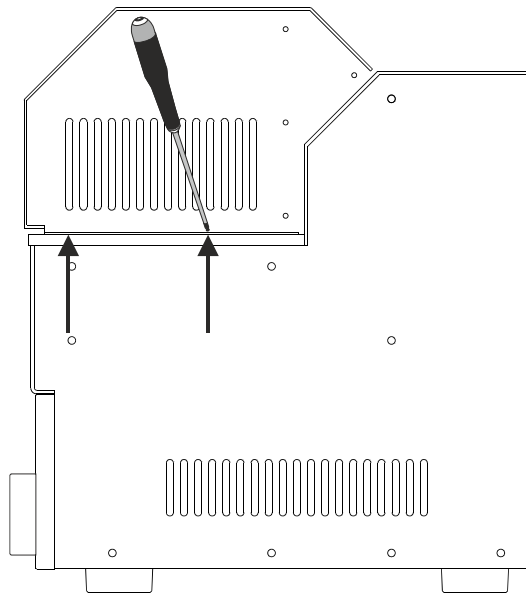

Procedure

- ① For your own safety, make sure that the amplifier is not connected to mains.
- ② Completely remove the four hexagonal screws using the Allan key supplied. There are two screws on each side.
- ③ Carefully pull the grille upward to remove.

3. GETTING STARTED

3.3. Installing the power tubes

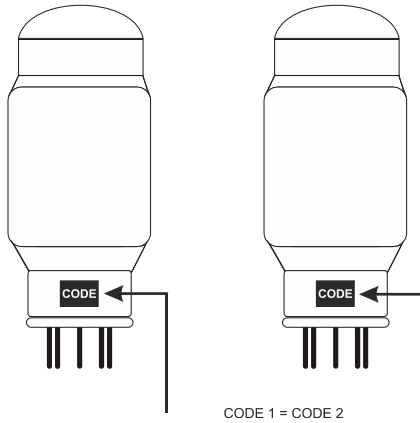

The output tubes you get from Octave are matched with an identical or up to +/- 0.5 match code

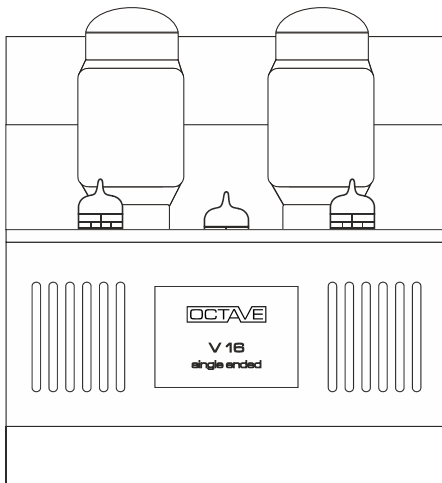

Therefore you can insert the power tubes wherever you want (position 1 or position 2; see chapter 7 "Tubes")

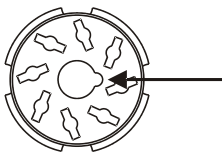

Anti-rotation recess on the tube socket

Insert the power tubes into their sockets. Ensure that you correctly locate the anti-rotation lug on each of the tubes

3. GETTING STARTED

3.4. Switching on for the first time – the Soft-Start feature

The V 16 Single Ended is equipped with a multi-stage Soft-Start-Turn-On protection circuit which extends component as well as tube life considerably by protecting against stress caused by typical high inrush currents during switch on.

Procedure

- ① Check that the volume regulator is set to 0, check if the mains switch is in position 0.
- ② Connect the V 16 Single Ended to the mains.
- ③ Switch on the V 16 Single Ended using the amplifier's mains power on/off switch. Some LEDs will glow, depending on the position of the input- and function-push-buttons: In any case one of the input-LEDs will shine indicating that the unit is active. The LEDs below the function push button will light up depending on the setting. After a few minutes start up time the unit will be ready to play music.

3.5. Connecting other components

Procedure

- ① Be sure to switch off the V 16 Single Ended again!
- ② Connect the other components of your system to the appropriate sockets on the rear of the V 16 Single Ended. (See chapter 5 "Connections – the rear panel").
- ③ Switch on the V 16 Single Ended using the on/off switch and wait a few minutes. Now you can play music.

4. CONTROLS – the front panel

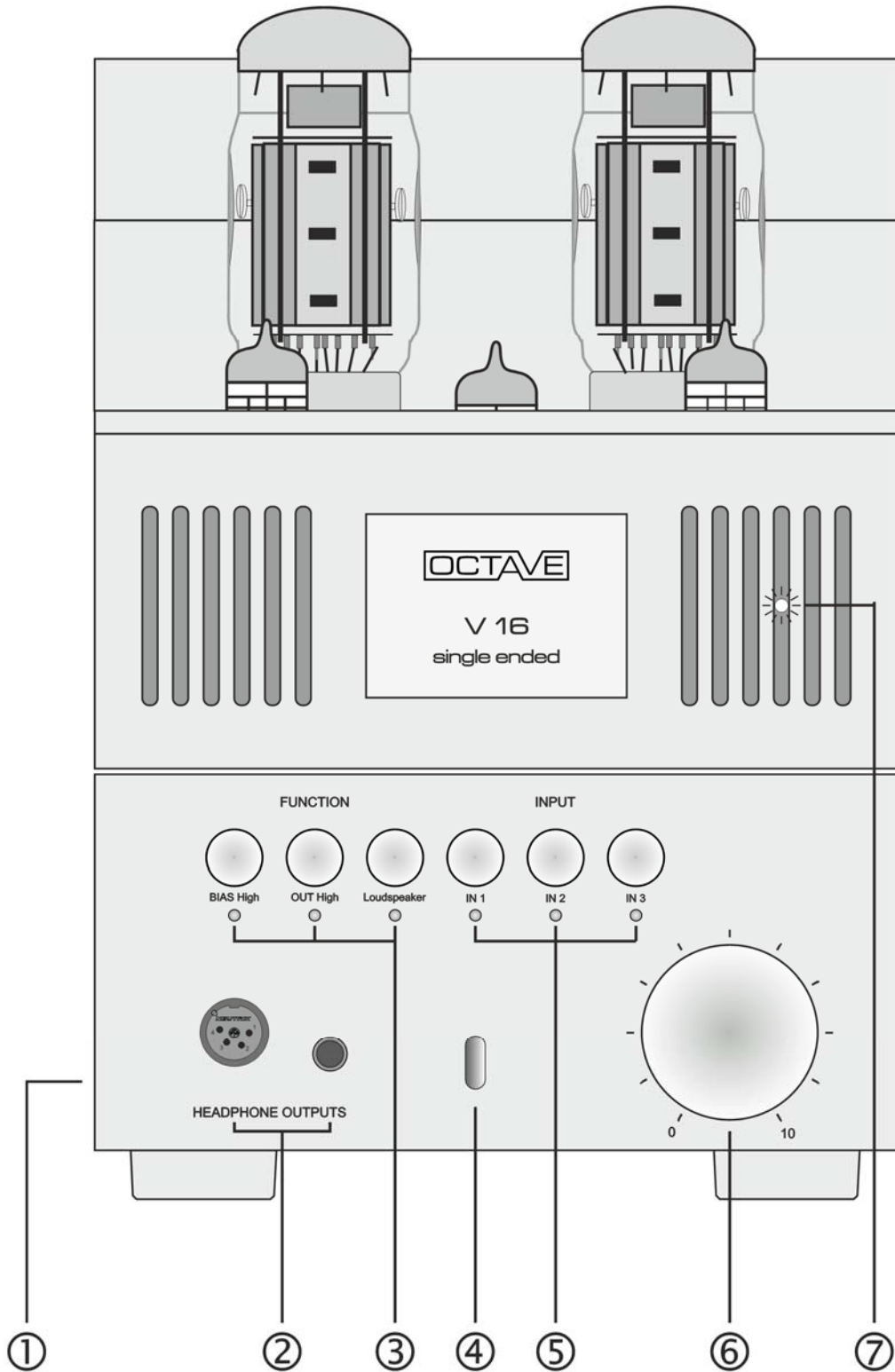

4. CONTROLS – the front panel

Legend	
① Power switch	0 = off; 1 = on. The LED from Input 1, 2 or 3 lights up.
② HEADPHONE OUTPUTS	The XLR and the 6.3 mm outputs are connected in parallel, therefore you can connect two headphones at the same time without any problems.
③ FUNCTION	<p>BIAS High: Sets the maximum idle current of the output tubes. BIAS High with the LED shining: This is the setting for low impedance (4 ohms) speakers. BIAS High with the LED off: The idle current of the output tubes is reduced. This is the recommended setting for speakers with an impedance higher than 4 ohms.</p> <p>OUT High : Sets the maximum output level. OUT High with the LED shining: This is the recommended setting for loudspeaker operation and for high impedance headphones. The maximum output level is 9 V. OUT High with the LED off: This position is recommended only for Headphones with a very high efficiency. The maximum output level is 4 V</p> <p>Loudspeaker: Switching between loudspeaker and headphone output. If the Loudspeaker is in operation the LED is shining.</p>
④ Remote control receiver	To ensure optimum operation of the IR-remote control, do not cover this window.
⑤ Input	Here you can select the desired input signal. A blue LED indicates the selected input below the corresponding push button switch. Pos 1: IN 1 RCA line level input for CD, SACD and similar. Pos 2: IN 2 RCA line level input for tuner, etc. Pos 3: IN 3 XLR line level input for DAC, CD, SACD, etc.
⑥ Volume control	Remote controlled motorized potentiometer.
⑦ Protection	A red LED lights up in the louver when the electronic protection system has switched off the amplifier in case of an amplifier or tube fault (see chapter 6.2 "Protection").

5. CONNECTIONS – the rear panel

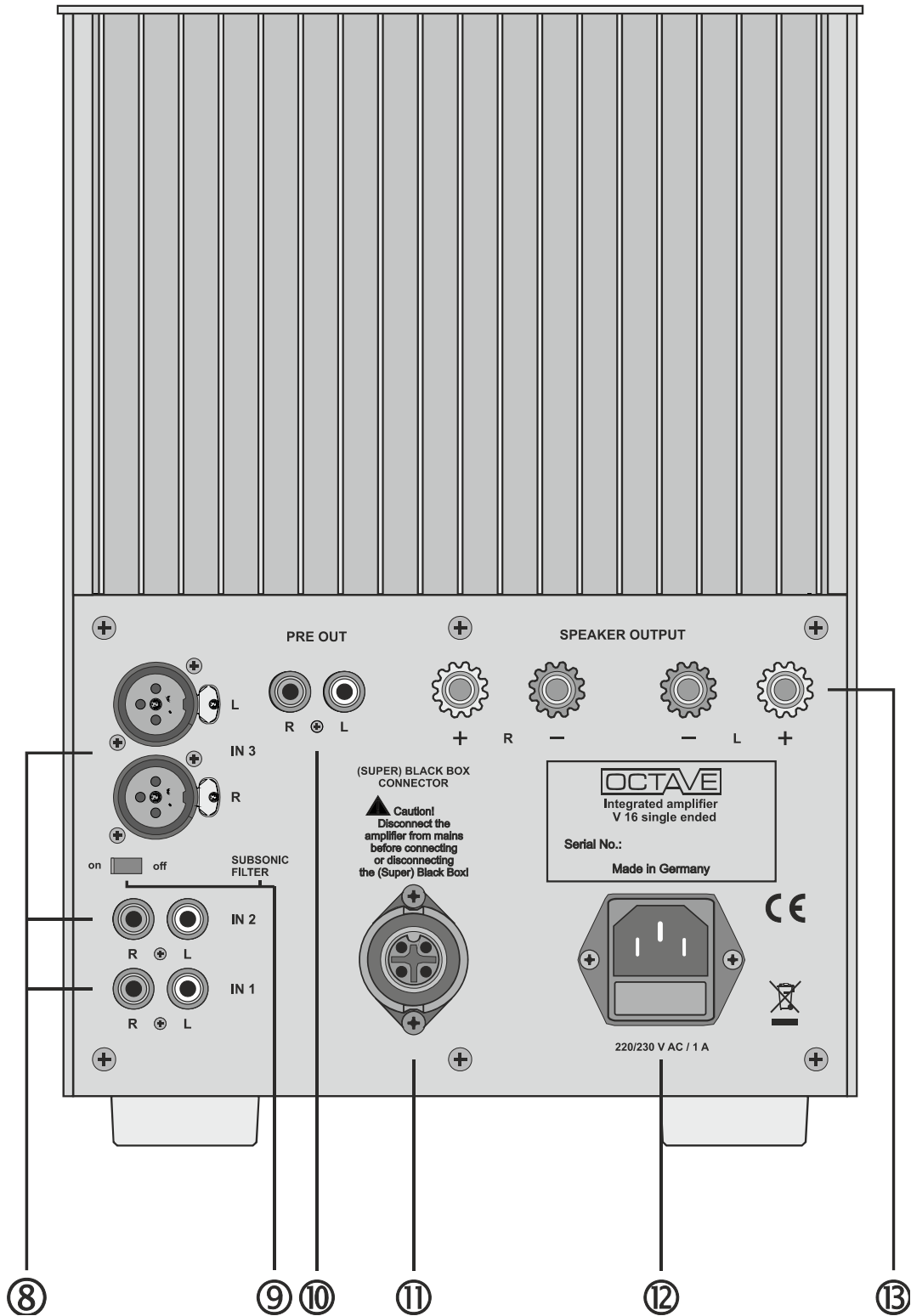

5. CONNECTIONS – the rear panel

Legend	
⑧	<p>Inputs</p> <p>IN 1: RCA line level input for CD, Tuner etc. IN 2: RCA line level input for CD, Tuner etc. IN 3: Balanced XLR line level input for CD, DAC etc.</p>
⑨	<p>Switch for Subsonic filter</p> <p>The subsonic filter is active at all inputs. Subsonic filter “ON” is recommended in case of any analog playback if the phono-preamp for example has no internal subsonic filter.</p>
⑩	<p>Pre Out (optional)</p> <p>Regulated preamp output (see chapter 9 “Option Pre-Out / Filter Function”).</p>
⑪	<p>(Super) Black Box connector</p> <p>The (Super) Black Box is an outboard power supply capacitance upgrade for the power amplifier section (see chapter 10 “Option (Super) Black Box”).</p> <p> You should switch off the V 16 Single Ended using the power switch before connecting and disconnecting the (Super) Black Box!</p>
⑫	<p>AC supply socket</p> <p>IEC socket with integrated fuse holder. The fuse is located in a pull-out compartment underneath the socket. You can open the fuse compartment after removing the mains plug.</p> <p>For 230/240 V: 2.5 A slow-blow H (5 x 20 mm). For 115/240 V: 4 A slow-blow H (5 x 20 mm). For 100 V: 4 A slow-blow H (5 x 20 mm).</p>
⑬	<p>Loudspeaker outputs</p> <p>Speaker connection terminals. Red = positive terminal Black = negative terminal The speaker negative terminal is connected to ground.</p>

6. ADVANCED FUNCTIONS

6.1 Subsonic Filter

Single ended amplifier designs are sensitive in respect of extremely low frequencies below 20 Hz. Such low frequencies can occur during analog playback and in blockbuster soundtracks. Therefore the subsonic filter prevents distortions caused by low level signals. The subsonic filter is a second order filter design, cutoff frequency is 22 Hz / - 3 db.

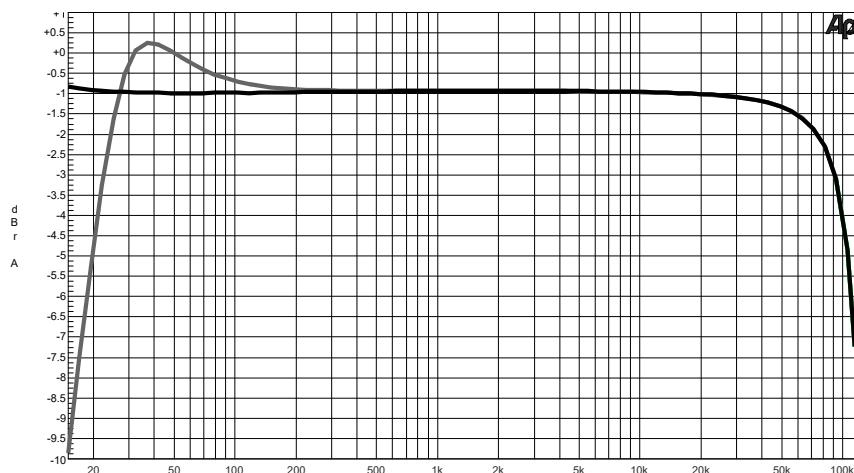

The subsonic filter is active for all three inputs and can be switched OFF or ON with switch (9) (see chapter 5 “Connections – the rear panel)

6.2. Protection

The V 16 Single Ended features a comprehensive electronic monitoring and protection system. This system will automatically switch off the V 16 Single Ended in case of a fault occurring in the power section, respectively the power tubes. The protection system has been designed to keep the unit safe from all consequences of overloads of any kind and to protect the output tubes from current surges.

The red “protection” LED lights up in the ventilation louver [No. (7), chapter 4 “Controls – the front panel”] to indicate that the protection system has tripped.



The amplifier will not play music once the protection system has tripped

If a Black Box or a Super Black Box is connected to the V 16 Single Ended, the front panel (operate) LED of the Black Box / Super Black Box will go out. If the (Super) Black Box is connected, tripping the protection system will automatically activate the discharge circuit of the (Super) Black Box (see chapter 10 “Option (Super) Black Box”).

The following conditions can cause the protection system to trip:

- Overdriving the V 16 Single Ended to excessive levels or with excessive levels of low-frequency.
- A fault in one or more of the output tubes.
- A fault in one of the driver tubes which overloads the affected channel.

Once the protection system has tripped, the only way you can turn the V 16 Single Ended back on is to turn the ON/OFF switch OFF and then ON again. Allow the unit two minutes to cool down before switching back to ON. If possible, identify and eliminate the cause of the problem (see chapter 11 “Troubleshooting”).

6. ADVANCED FUNCTIONS

6.3. Soft-Start

The V 16 Single Ended input- and output-tube-heaters as well as its high-voltage-rails are logic controlled to ensure that the operation of the output tubes as well as input stage voltages are constantly monitored and controlled by the **Power Management System** to protect the vital internal parts (tubes, rectifier, electrolytic caps, switches, etc.) against excessive turn-on current. This increases the lifetime not only of the tubes, but also of the capacitors, while all other power related components derive benefit through this system.

The Soft-Start is always activated within the first 60 seconds after the unit is switched on. During this time you cannot listen to music, there will be no signal in the speaker- and headphone-outputs.

6.4 Speaker Operation - BIAS Selector

The V 16 Single Ended is equipped with a BIAS selector. The BIAS selector allows to switch between two BIAS settings. BIAS means the idle current of the output tubes. The value of the idle current is directly related to the loudspeaker impedance. The lower the impedance the higher should be the idle current for best performance

Changing the idle current is a practicable way to match the output Class-A-stage to the load impedance perfectly. An additional positive aspect is to avoid unnecessary high current and heat because of an idle current that would be too high in respect to the load resistance.

The values you can select with the BIAS selector – High and Low – correspond with the speaker impedance 4 and 8 ohms. **Most of the high efficiency speakers have an impedance of 6 ohms or higher, therefore you should select BIAS Low as the standard setting.** In case of bi-amping, with the V 16 Single Ended connected to the middle- and high-frequency-speakers of the bi-amped speakers, you should also set the BIAS to Low.

For all speaker applications you should set the Output selector to OUT High.

6.5 Headphone Operation - OUT Selector

In case of headphone operation, the BIAS High is not meaningful due to the high impedance of headphones in general. Therefore the BIAS is internally programmed in headphone setting to a value that ensures the best results with headphones. The BIAS selector is therefore not active in this mode. The idle current is reduced because of the low output power and is optimized for headphones with an impedance down to 10 ohms and higher.

The most headphones have an efficiency that matches to the setting OUT High, but in some rare cases headphones have a very high efficiency and an impedance lower than 25 ohms. In these cases we recommend to change to the OUT Low position. The maximum output level is limited to 4 V in this position, preventing the user against excessive level and is protecting the headphone against damage.

6.6 Ecomode

The Ecomode electronic in the V 16 Single Ended is a signal sensing electronic system that controls the idle current of the power tubes. In case of no music playback longer than 2 minutes the Ecomode drives the idle current down to 35 %. The unit is still working in this mode. If the playback starts again the Ecomode is releasing the BIAS (idle current) to the adjusted value – High or Low – in the loudspeaker mode. This process is not noticeable and needs only 10 seconds to restore the selected BIAS level.

Thus power consumption during music pauses and the dissipation heat is reduced.

7. TUBES

7.1. Removing the grille

See chapter 3.2.

7.2. Tube layout

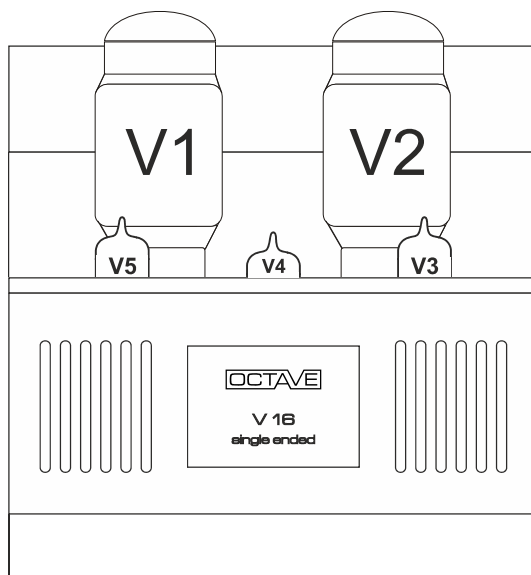

Output tubes	V1 – V2	KT120 as standard, gain selected. Marked with a match code in numbers. It can be the same or a variation of up to +/- 0.5. Because the tubes are precision selected, you can insert the power tubes wherever you want (position 1 or position 2)
	V1	left channel
	V2	right channel
Driver tubes	V4	ECC 82 (12 AU 7) gain selected
	V3 + V5	EF 800, equivalent to EF 184, 6 EJ 7

The triode output stage topology in combination with the electronic controlled cathode BIAS system of the V 16 Single Ended makes it possible to use a variety of output tubes. Because the specification limits of the tubes are never exceeded in this particular mode, weaker output tubes may also be considered. This is facilitated by the option of setting the BIAS current to two different values: BIAS low and BIAS high.

Low BIAS: 8 ohms speakers. Alternative output tubes: EL 34, KT 77, 6 CA 7, 6550, KT 88

High BIAS: 4 ohms speakers. Output tubes: KT120, KT 150

Due to the high impedance and the high efficiency of headphones you can use all output tubes in case of listening headphones only. In the setting headphone the BIAS (idle current) is electronically controlled and reduced to a lower level than BIAS Low. The BIAS High/Low push button selector is not active in the headphone position.

Note: Low BIAS tubes will not allow you to achieve the maximum output of the V 16 Single Ended. We do not recommend using them with low efficiency or low impedance loudspeakers. Some tubes will fit into the sockets but will still not work with the V 16 Single Ended – such as the EL 509 or 519 for example.

7. TUBES

7.3. Replacing the tubes

Driver and Output tubes: All tubes require no adjustment in the V 16.

General procedure

-  1. Switch off the amplifier and allow it to cool down for 10 minutes. Remove the old tubes and fit the new ones.
2. Switch on the amplifier and wait for 10 minutes to let the new Tubes to get stabilized. The amplifier should work after this time.

7.4. Running in the tubes

All OCTAVE equipment is subject to a 48-hour continuous operation test at the factory to burn in the tubes and the unit. The tubes are preselected and matched for the use in each particular model. **The Output tubes have a match code on the socket. Tubes with the same or +/- 0.5 match code ensure low channel tolerances of +/- 0.2dB.**

Old and even New tubes can take up to one month to run in and start sounding their best.

Daily use is beneficial in speeding up this process but is not mandatory. Continuous operation does very little to help reduce the running-in time and is therefore ***not*** recommended.

7.5. Tube service life

- Thanks to the protection circuits and soft-start electronics, the output tubes in your amplifier should achieve a service life of up to 3 - 5 years.
- Driver tubes can be used for 10 years or even longer.
- Because tubes have different service lives, you will never have to renew the entire tube complement at the same time.
- Some tubes require a long time (up to 300 hours) to achieve their optimum sound quality.

8. THE REMOTE CONTROL

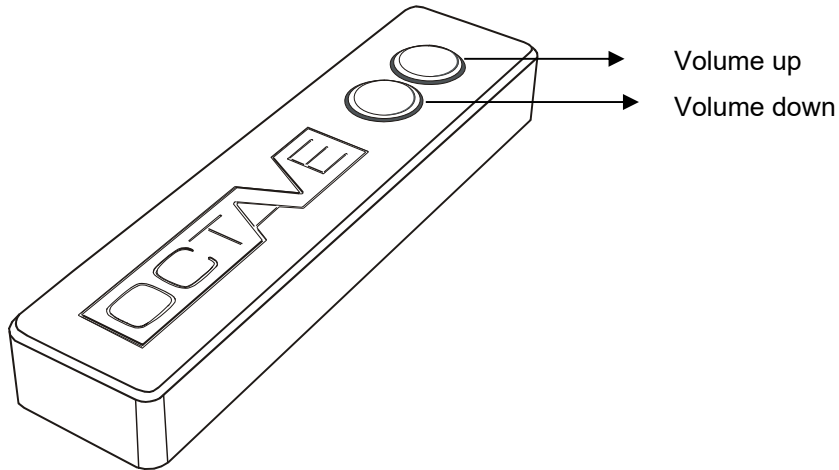

Changing the batteries

1. Remove the bottom plate (three screws size Phillips 1)
2. Change the batteries. Type: 2 x Type AAA 1.5 V.
Please take care not to push the buttons of the remote control while inserting the new batteries.
If it still happens that the remote control does not work after changing the batteries, remove the new batteries and wait for the minimum of 2 hours. After 2 hours you can insert the new batteries again and the remote control should work
3.  Install the bottom plate again, tighten the screws not too hard.
NOTE: Please don't trash the old batteries. Batteries must be disposed of as special waste. Stores that sell batteries should provide containers for the collection of used batteries.

9. Option Pre-Out / Filter Function

9.1 Regulated preamplifier output – Pre-Out

It is not possible to upgrade a V 16 Single Ended without the option Pre-Out to the version with Pre-Out. This decision must be made when the device is purchased.

The option regulated Pre-Out allows you to use an active Subwoofer or bi-amping if the loudspeaker is constructed for bi-amping.

The Pre-Out has an internal output circuit with a low output resistance. The length of the cable to the external unit is therefore not an issue. Furthermore the output amplifier eliminates interferences of the cable and the connected unit that would otherwise affect the sound of the V 16 Single Ended. The output amplifier is designed for the highest sound quality and matches with the sound of the V 16 Single Ended.

The Option Pre-Out comes with an innovative additional function. This is the filter function for the V 16 Single Ended output stage. It is easy to understand that it makes no sense to burden the V 16 Single Ended with the whole frequency response when the bass part is applied to the external power amplifier or subwoofer. Low frequencies with a high level are limiting the output power of a single ended amplifier as well as any other power amplifier with an output transformer.

To avoid this unnecessary stress we added a filter to get rid of the frequencies below 80 Hz. The filter is flat down to 80 Hz / -3 dB. This low roll off frequency does not affect the middle- and high-frequency sound characteristics.

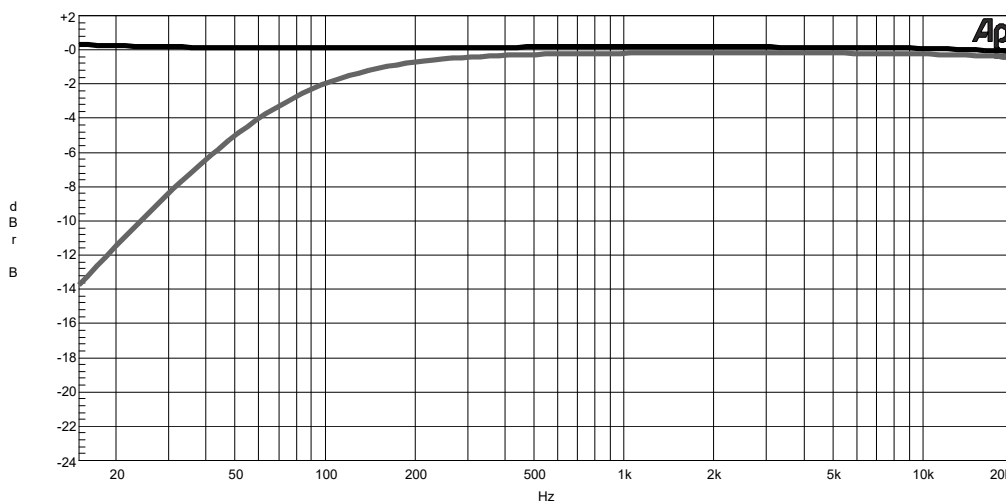

Frequency response of the V 16 with and without the low frequency filter

As a result of this filter design the dynamics and the undistorted output power of the whole bi-amping configuration increases by a multiple. The sound of the midrange also benefits from this technology - this is the most important aspect.

The filter can be set ON or OFF with jumpers inside the V 16 (see chapter 6.2 “Setting of the Filter Function”). If a headphone is active the filter is bypassed automatically. But in both cases the Pre-Out is always active.

9. Option Pre-Out / Filter Function

9.2 Setting of the Filter Function



To set the filter ON or OFF you have to remove the side panel. This work must be done by a professional electronics

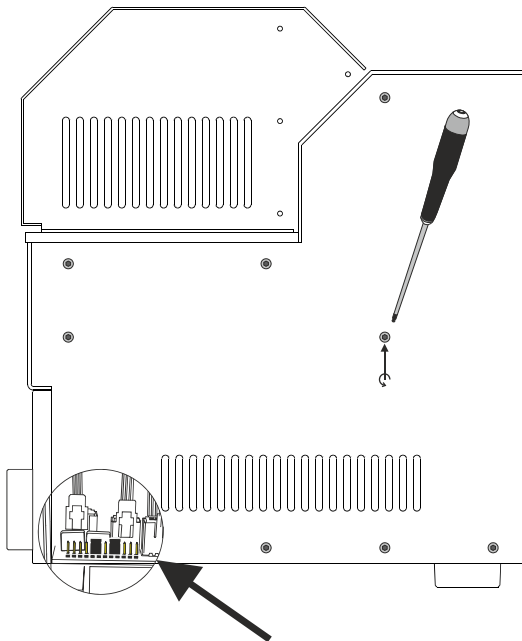

To have access to the filter settings you have to remove the right side panel. You need a screwdriver Torx T10. Please make sure that the unit is disconnected from the mains and has cooled down for at least 10 minutes. After removing the side panel you find the Filter setting facility near the Volume regulator.

9.2.1 Jumper setting "OFF"

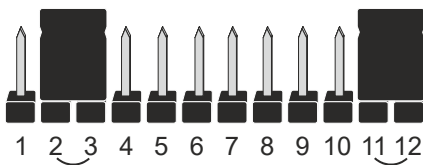

Jumper setting using the V 16 Single Ended output stage without the low frequency Filter OFF: Jumper setting pin 2/3 and 11/12

In case of a full-range high efficiency speaker it makes no sense to use the Filter, except you want to add an active or passive subwoofer.

9.2.2 Jumper setting "ON"

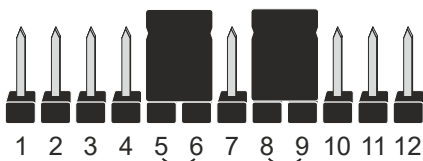

Jumper setting using the V 16 Single Ended with the low frequency filter Filter ON: Jumper setting pin 5/6 and 8/9

In case of a two or three way high efficiency speaker with a large woofer it makes sense to set the Filter ON.

The factory setting is Filter OFF

9. Option Pre-Out / Filter Function

9.3. Setup with an active subwoofer

The regulated preamplifier output is most commonly used to drive an active subwoofer. The input impedance of the subwoofer is therefore non-critical.

The Pre-Out does not have a separate muting function to prevent switch-on or switch-off noise from the V 16 Single Ended. This is normally not needed, however, since the active crossover in the subwoofer electronics will block unwanted DC and low frequency signals.

During listening with headphones the subwoofer should be switched OFF.

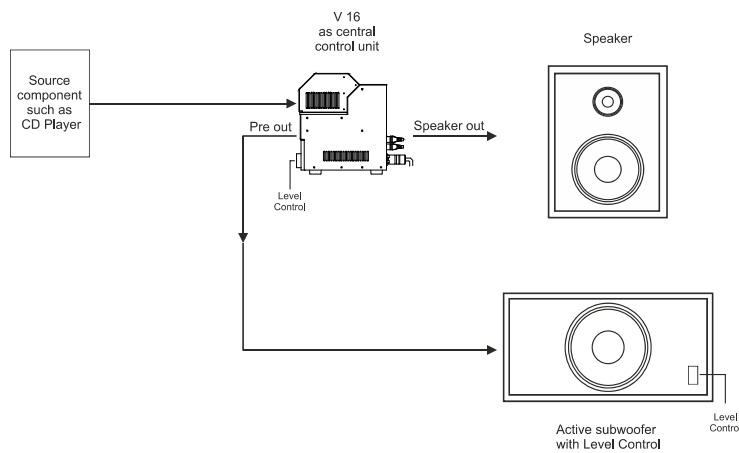

9.4. Bi-amping system

Another option provided by the adjustable Pre-Out is bi-amping via the V 16 Single Ended's Pre-Out. The V 16 Single Ended would ideally handle the mid/high portion of a bi-amping setup, using a second power amplifier fitted with its own volume control to take care of the bass. In this configuration, switch-on/switch-off noises from the Pre-Out may be audible. The best way to deal with this is to make sure switching on the V 16 Single Ended at first, then the external power amplifier - and when switching the units off do such in the reverse order.

Configuration of the V 16 Single Ended in bi-amped systems

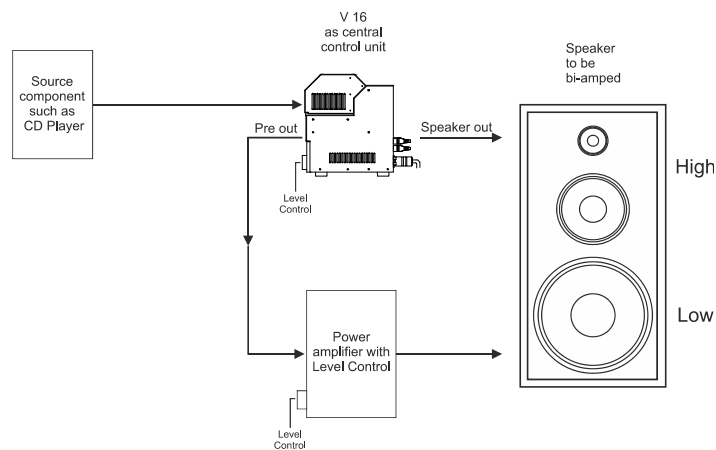

9. Option Pre-Out / Filter Function

9.5. Bi-amped system with the “Level Adjustor”

Selecting a power amplifier with a level regulator or selecting a power amplifier that has the same gain or input sensitivity as the power output amplifier in the V 16 Single Ended is hard to find – or more or less impossible. For this reason we offer an external box: The Level Adjustor optimized for stereo power amplifiers. This small additional unit allows you to adjust the bass level precise to the level of the V16 Single Ended output stage, thus resulting in a homogenous sound. For technical reasons the Level Adjustor must have a short signal connection to the external power amplifier. This way, the cable length between the V 16 Single Ended to the Level Adjustor, respectively the power amplifier is not critical. Up to 3 meters is not an issue. The output signal cables to the power amplifier are permanently attached to the Level Adjustor. The Level Adjustor has a channel match of 0.2 dB in the entire setting range.

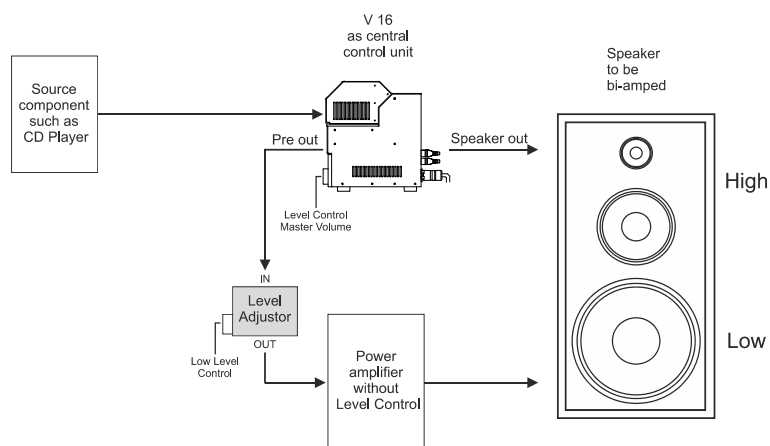

9.5.1 Level Adjustor option

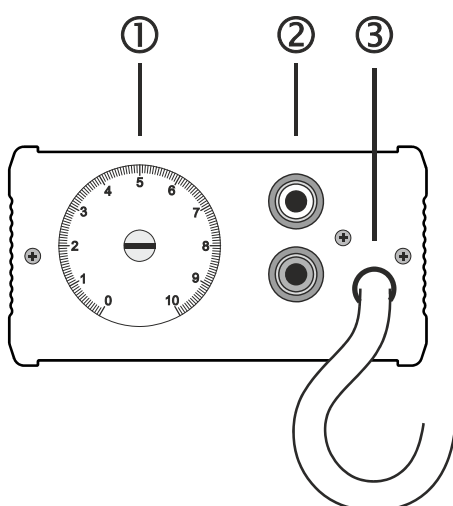

- ① Regulator to match the level between the V 16 Single Ended and the separate power amp for the bass.
The regulator in the middle of the scale (it looks like a screw) is adjustable with a slotted screw-driver.
- ② RCA Connector: White = Left Channel
 Red = Right Channel
- ③ Signal Out to the Power Amplifier
 White = Left Channel
 Red = Right Channel

Technical Data:

Adjustment Range: -8...-34 dB
 Input impedance Power Amp.: 5-100 kohms
 Dimensions: 10 x 8 x 4,2 cm
 Weight: 0.28 kg

10. OPTION (SUPER) BLACK BOX

Description

With the Black Box technology OCTAVE offers an instrument for optimizing the OCTAVE amplifier in respect to the speaker. This flexibility is a unique feature of the OCTAVE brand.

The dynamic and tonal stability of an amplifier is strongly dependent upon the stability and capacity of the power supply, therefore the Black Box and Super Black Box were developed as external upgrades to the OCTAVE amplifiers' power supply storage capacitors by increasing their capacitance by a factor of 4 (Black Box) or 10 (Super Black Box), respectively. This is a tremendous benefit if the speaker is difficult to drive. Loudspeaker efficiency is made less critical, while the amplifier is enabled to handle speakers with minimum impedances as low as 2 ohms. The power supply capacitance increase stabilizes current delivery and reduces the impedance interaction of the load. This improves dynamic range, separation, depth, soundstage size and articulation, rendering the musical reproduction clearer throughout the entire frequency range. The amplifier remains unaffected by mains variations and interferences due to the noise filtering characteristics of the capacitors

10.1. The Black Box option

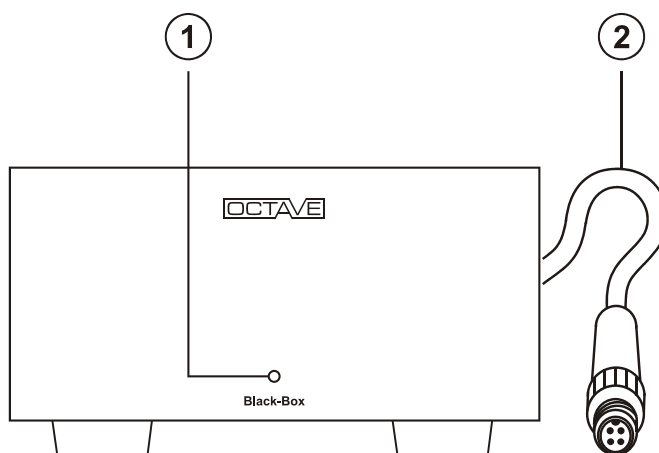

Legend

(1) Indicator LED	The LED illuminates continuously when the power amplifier is on. The LED goes out when the protection circuitry trips. This is normal, because the protection circuitry cuts the power to the amplifier
(2) High-current plug	

10.2 Connecting to the amplifier



- Important! Before connecting the Black Box, switch **off** the unit using **the power switch and wait for 1 minute**.

When inserting the connector, guide the anti-rotation lug carefully into the mating recess in the socket.



- When you switch on the amplifier, the LED on the front panel of the Black Box will illuminate.
Note: The LED on the Black Box goes off when the amplifier's electronic protection circuitry is activated or the Ecomode has turned the unit down.
- Should you wish to disconnect the Black Box, switch off the amplifier first and **wait until the LED on the Black Box has gone out**.

10. OPTION (SUPER) BLACK BOX

10.3. Super Black Box option

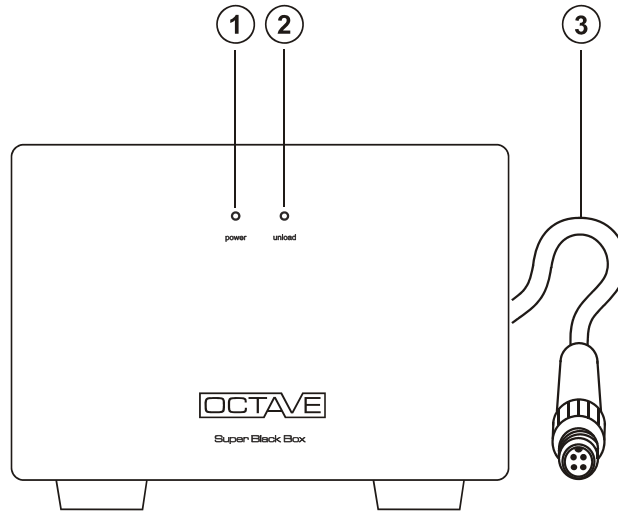

Legend

- | | |
|------------------------------|--|
| (1) Blue power LED | The blue “power” LED illuminates when the power amplifier is switched on via the amplifier’s power on/off switch. |
| (2) Yellow unload LED | The yellow “unload” LED (discharge control circuit) lights up for approximately 2 seconds after switch-off, in case the electronic protection is activated and if the amp is powered down through the Eco-mode. The Super Black Box is equipped with a rapid discharge circuit, which discharges the unit’s capacitors. The yellow LED indicates that this procedure is taking place. The discharge circuit also activates if the SBB connecting cable is accidentally removed. This is to prevent the SBB maintaining its charge when it has not been properly disconnected |
| (3) High-current plug | (Connection see Black Box.) |

10.4 Technical Data

10.4.1 Black Box

Specifications

Dimensions	178 x 98 x 300 mm (W x H x D)
Weight	3.1 kg
Connection cable	Length: 90 cm (with plug). Longer lengths are available upon request

10.4.2. Super Black Box

Specifications

Dimensions	203 x 149 x 360 mm (W x H x D)
Weight	5.6 kg
Connection cable	Length: 90 cm (with plug). Longer lengths are available upon request

11. TROUBLESHOOTING

11.1. Faults caused by external issues

Buzzing and hum in the speakers

◆ **Possible cause: multiple grounds**

Hum in an audio system is often caused by several system components having their own separate earth connection. It is particularly common in systems containing tuners, VCRs or satellite receivers, as these components are connected to an aerial. Because aeriels and cables are always grounded, ground loops can form between the aerial connection and other grounded equipment. Other equipment that is normally grounded may include PCs with sound cards, and some CD/DVD players and DACs.

Although the V 16 Single Ended is grounded, its signal ground is a "floating" ground, which means that the V 16 Single Ended cannot create ground loops by itself. Hum can only be caused when it is connected to other items of equipment.

To fix the problem

Before trying to fix the problem, find out which of your system components is responsible for generating the hum.

Procedure:

- Unplug all source equipment from the V 16 Single Ended, leaving only the loudspeakers connected.
- Reconnect the components back to the V 16 Single Ended one at a time. As soon as the hum reappears, you have two grounded components connected to the V 16 Single Ended. You must now unplug your components in reverse order to find out which of them is grounded.

Usually, the hum will still appear even when the problem components are switched off. The ground causing the problem is always connected, since it is not broken when the power switch is operated.

Now that you know which components are grounded, you can discuss the problem with your dealer. One option might be to use a signal-isolating filter on the aeriels or cable networks. These devices do not normally have any adverse effect on the sound or picture quality of tuners or TVs. Other possible solutions could include using an isolating transformer or an isolating device offering complete galvanic isolation. Please seek the advice of a specialist.

Power strips with built-in filters, mains filters or replacement mains cables are not appropriate solutions.

Note

Switching power supplies are quite common nowadays. These are often fitted with a protective earth terminal (PE) and an RFI filter. When using such units, the protective earth terminal **must** be connected to the wall socket. **You must never remove this protective terminal, as doing so could cause high levels of radio frequency interference to enter your system, which could affect the operation of other digital equipment, including remote controls.**

11. TROUBLESHOOTING

◆ Possible cause: induction

Another possible cause of hum could be the stray field of a transformer generating interference in a device or cable. You can easily diagnose this problem by switching off the problem component.

To fix the problem

To reduce this kind of interference, move the transformer/component or the affected component/cable to a different location.

The transformer in the V 16 Single Ended will not generate interference, as it is electromagnetically shielded and has a very low stray field.

◆ "Phase" does not cause noise and hum

The mains polarity of the components in your system has no effect on noise and hum. That is a common fallacy. Swapping positive and negative in your mains plug will not make any difference to an earth loop. If it does, there is a fault with that component and you should not be using it.

Channels are not balanced

Level differences can have a variety of causes, although tubes are unlikely to be one of these.

1. The acoustics of the listening room may be affecting what you hear.
2. One of the drivers in your loudspeakers may be faulty.
3. There may be a faulty cable in your system

To fix the problem

You can trace the cause of this kind of problem by swapping speakers, cables, etc.

11.2. Faults caused by tubes, faulty tubes

Like other OCTAVE products, the V 16 Single Ended is equipped with a double safety system. This means that the amplifier will be protected from damage if a component (tube) should fail and trip the electronic protection. The protection system protects the amplifier and the tubes from overload. This technology has proven its worth in recent years. *It has enabled us to reduce our overall failure rate (except for output tubes, which we are unable to control 100 percent) to virtually zero. OCTAVE equipment will achieve a service life of 10 to 15 years without needing to be serviced. We feel that this is particularly important aspect of tube equipment design, as many preconceptions still exist about the technology's durability and long-term stability.*

There are a number of reasons why tubes might fail at some point in their lifetime. You can find faulty tubes by examining their behavior.

Mechanical fault that does not trip the V 16 Single Ended's protection

◆ The tube's heater filament no longer glows

No matter whether it is a driver tube or an output tube, no tube can work without a properly functioning heater.

Output tube heater fault

When the heater system on an output tube fails, this tube does not work. A loose connection inside the tube could have caused the heater to fail. It may be possible to repair the connection by mechanical means.

11. TROUBLESHOOTING

Driver tube heater fault

When a driver tube heater fault occurs, you will normally lose an entire channel (depending on which driver tube system is affected by the faulty heater). This can only be established by a visual examination. The heater filaments are often difficult to see inside the driver tubes, since they only protrude very slightly from the tube system. OCTAVE uses double triodes, the Input tube V 4 for example, i.e. there are always two identical tube systems within the glass envelope. Because each of these triode systems has its own heater, you should always be able to see two glowing filaments. If you can only see one, it means that the tube is faulty. The other two driver tubes of the V 16 are single tubes with only one filament glowing.

◆ A tube has developed an air leak

The glass envelope of all tubes normally contains a vacuum. In order to maintain the vacuum throughout the service life of the tube, there is a device inside the tube that absorbs the residual gas. It is called the getter pill. It normally takes the form of a small crucible near the top of the tube. It contains a substance known as the getter, which absorbs and permanently retains the residual gas. This device ensures that the tube maintains a high vacuum during its entire service life. Hairline cracks around the base and leaks around the socket pins can cause the tube to take in air. Because the getter is only able to absorb a finite amount of gas, it will soon stop working. The silver coating at the top of the tube will then begin to discolor. As soon as a certain amount of air leaks into the tube, it will stop working completely and the heater filament will burn through.

Tube faults that trip the protection system

The protection system continuously measures the current flowing into the two power tubes. Depending on the problem, this current may exceed a specified limit and cause the protection system to switch the power stage off. The red protection LED will light up to show that this has happened. Once the protection circuit has been tripped, your amplifier will not produce any output. Exceeding the specified current limit can have a variety of causes.

◆ Faulty output tube

Aging and mechanical stresses from rough handling during transport can create an unwanted connection inside the tube, which can lead to failure of the tube.

How can you recognize a faulty tube? If you do not know what fault caused your amplifier to cut out, it is a good idea to disconnect the speakers and switch the V 16 Single Ended off and on again.

- You can switch ON the V 16 Single Ended with only one Output Power tube to check which tube is faulty.

◆ Faulty driver tube

In very rare cases, a problem with one of the driver tubes can cause the V 16 Single Ended to switch off. If one of these tubes is indeed responsible for the problem, output tubes in the affected channel will behave erratically.

- you can turn ON the V 16 Single Ended without the driver tubes to check if one of the driver tubes is responsible for the issue.

◆ Tube faults that degrade the sound

These faults are relatively uncommon and usually a result of a fault already described above. Thanks to the controlled soft-start circuitry, the tubes will retain their tone throughout their working life. The V 16 Single Ended's sophisticated, low-noise power supply circuits push hum and noise down to negligible levels. Tubes do not inherently produce hum or hiss: these problems are simply side effects of older, classic tube technology.

Noise, crackling or similar undesirable noises can be caused by residual gas or other residues in the tubes. This kind of noise does not often reach a level that could be considered annoying, although the nearer to the "front" the particular tube is, the more it will tend to make itself felt. In the V 16 Single Ended, this would be tube V 4. As it is rare for both systems in a double triode to be equally affected, the noise levels in each stereo channel will be different.

12. SPECIFICATIONS AND DIMENSIONS

Output configuration: Single ended Class-A, triode mode, idle current tubes 30 mA – 70 mA

Headphone operation: BIAS Low and BIAS High.

Load impedance: 3 - 32 ohms nominal speaker impedance.

Impedance headphone: 6 – 32 Ohms Out Low. 8 – 2000 ohms Out High

Speaker efficiency: greater than 93 dB.

Negative grid voltage electronically controlled for each output tube.

Wideband output transformers using Silicon steel PMZ Core.

Amplifier remains stable with no load.

In- and Outputs	
Inputs	2 x RCA 1 x XLR
Outputs	1 x Loudspeaker output 1 x Headphone output 6.3 mm jack 1 x Headphone output 4 pin XLR 1 x Regulated preamplifier output RCA (optional)
XLR Input Pin Out	1 = ground, 2 = plus, 3 = minus
Output stage	
Output Power into 4 ohms	Power Selector High 2 x 8 W RMS Power Selector Low 2 x 5 W RMS
Frequency response	10 Hz – 80 kHz @ 5 W 0 / - 3 dB
THD / Distortion factor	0.5 % at 3 W into 4 ohms
Signal-to-noise ratio	-110 dB / 8 W
Output Noise	< 30 µV / 50 Hz to 400 Hz
Load impedance Loudspeaker	3 - 32 ohms (Bias High – Low)
Load impedance Headphone	6 - 2000 ohms (Out Low – High)
Minimum load impedance	2 ohms
Gain	26 dB
Output tubes	2 x KT 120
Quiescent current; output tubes	50 mA - BIAS Low, 70 mA - BIAS High 25 mA headphone setting
Input stage	
Input Impedance	50 kohms / RCA, 25 kohms / XLR
Input Sensitivity	400 mV
Crosstalk input to input	greater - 90 dB
Channel Separation	40 dB
Output Impedance Pre out	40 ohms
Max. Level Pre Out	5 V RMS
Driver tubes	1 x ECC 82, 2 x EF 800

The output is inverted in respect to the input, the Pre Out is in phase in respect to the V 16 Single Ended speaker output

12. SPECIFICATIONS AND DIMENSIONS

General data	
Inrush current limitation	220 W
Start-up time	50 seconds
Power consumption	200 W at full power 120 - 200 W depending on the BIAS and output setting speaker / headphone.
Weight	19.1 kg (19.6 kg with cable and remote control)
Mains fuse	For 230/240V: 2.5 A slow-blow H (5 x 20 mm). For 115/240V: 4 A slow-blow H (5 x 20 mm). For 100V: 4 A slow-blow H (5 x 20 mm).
Dimensions	Overall dimensions in mm 210 x 335 x 297 mm (width x height x depth)

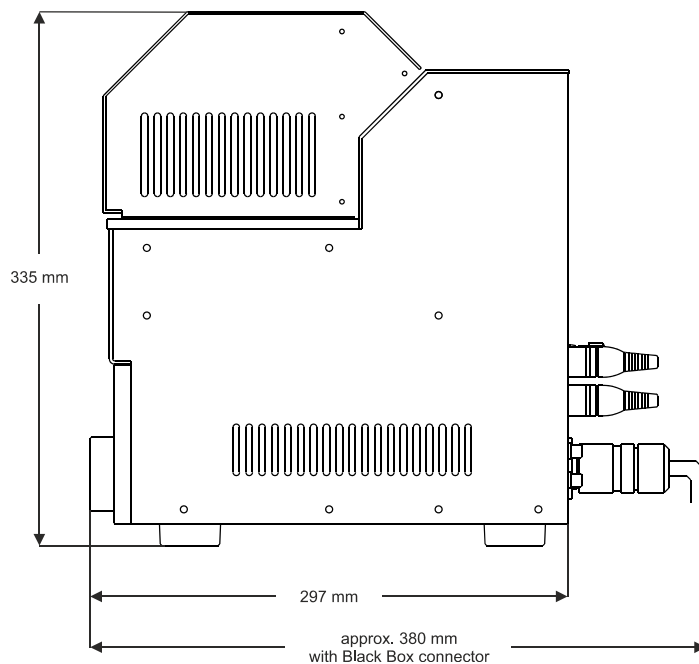
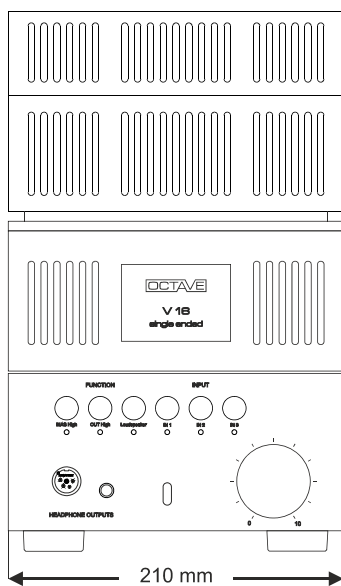



We reserve the right to alter and improve the specifications in pursuit of better. OCTAVE logo is a registered trade mark of Andreas Hofmann. Copyright by Andreas Hofmann. Reproduction in whole or part is prohibited.
edited

OCTAVE AUDIO
Germany
www.octave.de