

FRONT

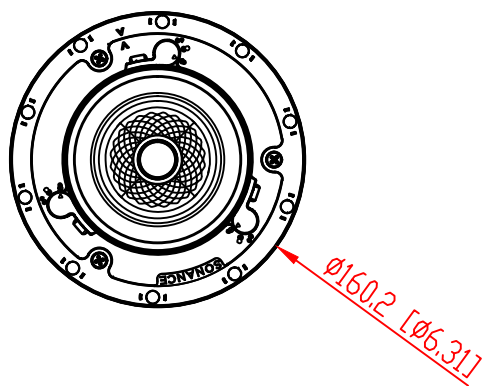

BACK / MINIMUM CUTOUT

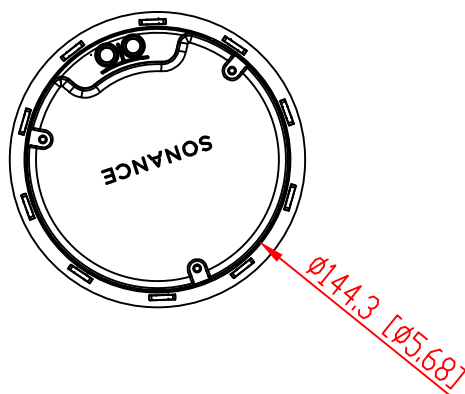

MOUNTING DEPTH

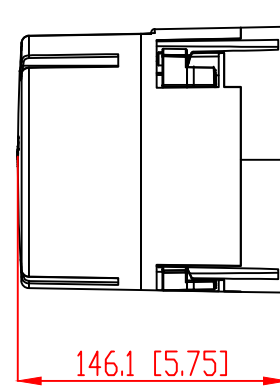

MICRO TRIM GRILLE

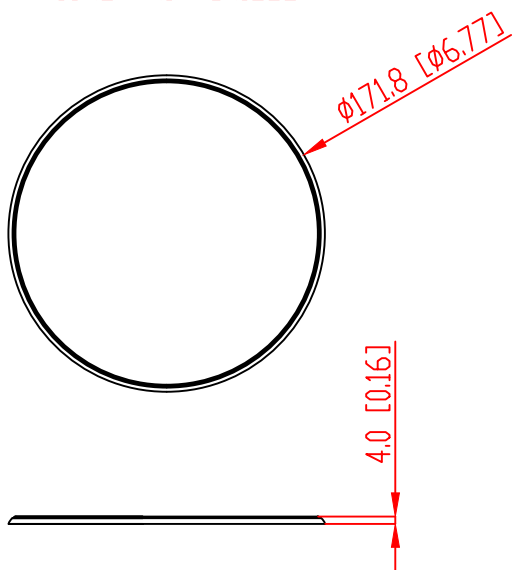

TRIMLESS GRILLE

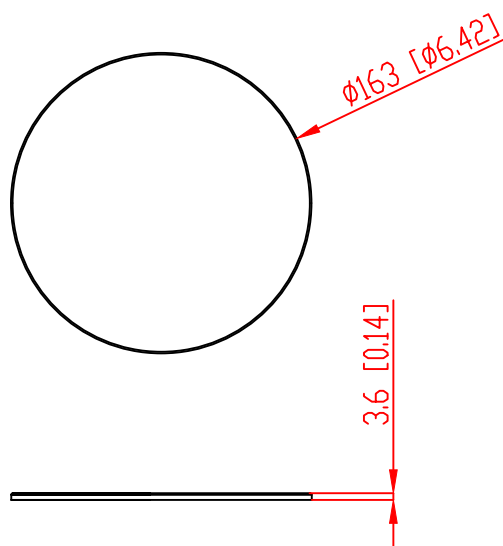

ISOMETRIC

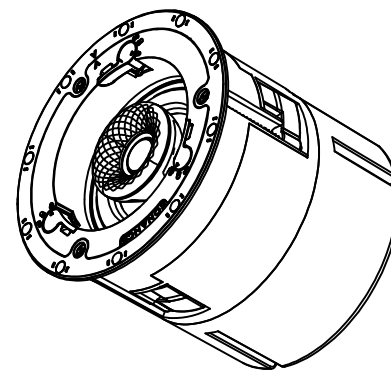

991 Calle Amanecer
 San Clemente, California 92673 USA
 949-492-7777
 www.sonance.com

SONANCE

VX42R WITH RETROFIT ENCLOSURE SPEAKER

SCALE: 1:1

DRAWN BY: Roy

DRWN - PART NUMBER

REV.

SHEET: 0F

RELEASED DIM