

FRONT

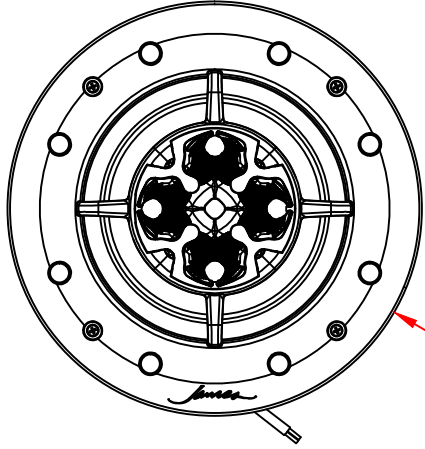

Ø281.10 [Ø11.07]

BACK / MINIMUM CUTOUT

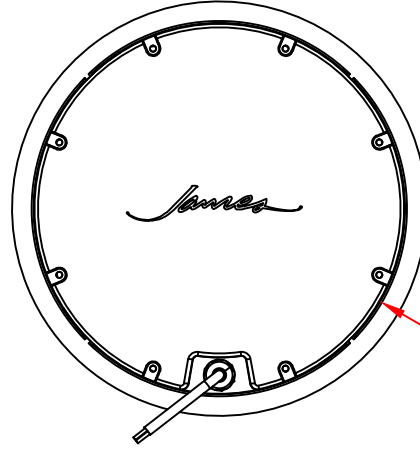

Ø254.5 [Ø10.02]

MOUNTING DEPTH

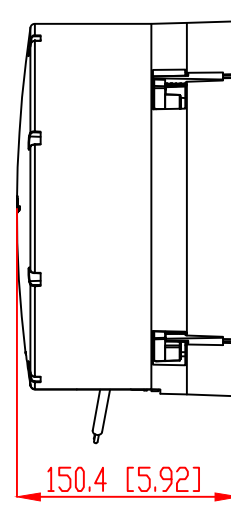

150.4 [5.92]

MICRO TRIM GRILLE

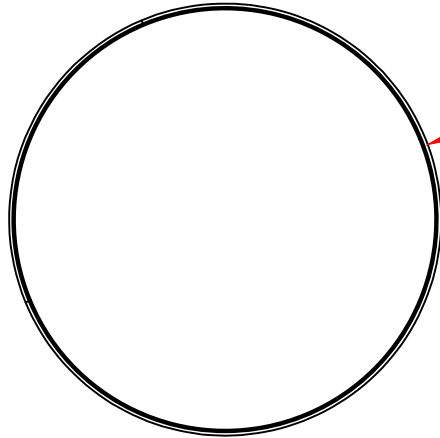

Ø293.2 [Ø11.54]

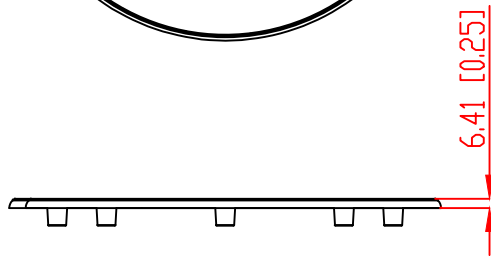

6.41 [0.25]

TRIMLESS GRILLE

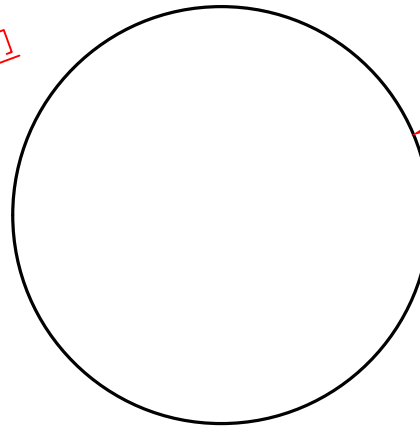

Ø283.8 [Ø11.17]

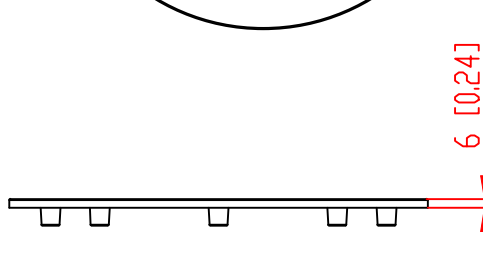

6 [0.24]

ISOMETRIC

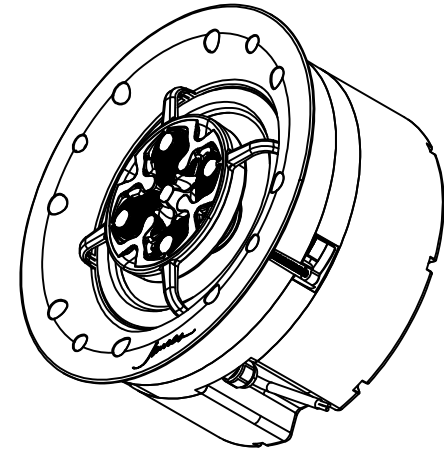

2185 Park Place
Minden, Nevada 89423 USA
775-461-7500
www.jamesloudspeaker.com



VX088R WITH DEEP ENCLOSURE SPEAKER

SCALE: 4:5
SHEET: 0F

DRAWN BY: Roy
RELEASED DIM:

DRWN - PART NUMBER

REV.